

TEST REPORT

no.: 240500150/3/EMC

Test name : Electromagnetic compatibility tests
Test subject : Household equipment
Product name : Thermostat for electric floor heating
Model : TR-01
Manufacturer : Trivolt s.r.o.
Diaľničná cesta 22B
903 01 Senec
Slovak Republic
Applicant : COCV TSÚ Piešťany
Krajinská cesta 2929/9
921 01 Piešťany
Slovak Republic
Testing location : Testing laboratory TSÚ Piešťany, a. s.
Krajinská cesta 2929/9
921 01 Piešťany
Slovak Republic
Order no. : 240500150
Test procedure : see chapter 2
Date of test : see chapter 2
Distribution : Copy no.1 – manufacturer
Copy no.2 – TSÚ Piešťany
Date of issue : 25.09.2024

 **TECHNICKÝ SKÚŠOBNÝ
ÚSTAV PIEŠŤANY, a. s.**
Krajinská cesta 2929/9
921 01 PIEŠŤANY
-213-



Tested by: **Ing. Jakub Šiška**
Testing engineer



Approved by: **Ing. Ľuboš Vančo**
Technical head of RED and EMC
testing body

Test results introduced in this test report are related to the test subject only and do not replace other documents required by the state supervisory authorities and according to other specific regulations. Test report can be reproduced or published as a whole, in parts only with written approval of TSÚ test body. The testing laboratory declines responsibility for information supplied by the customer that may affect the validity of the results.

CONTENTS

1	General information	3
2	Test methods and conditions.....	3
2.1	Environmental conditions	3
3	Summary of tests and test results	4
4	Performance criteria	5
5	Equipment under test.....	6
5.1	Description of EUT	6
5.2	Software and firmware	6
5.3	Test modes.....	6
5.4	Input / output ports	7
5.5	RF exclusion bands.....	7
6	Test equipment used	7
7	Emissions tests description and results.....	9
7.1	Radiated emission, Enclosure of ancillary equipment	9
7.2	Conducted emission, DC power input/output ports.....	15
7.3	Conducted emission, AC mains input/output ports	16
7.4	Harmonic current emissions, AC mains input port	19
	Result of test: PASS	21
7.5	Voltage fluctuations and flicker, AC mains input ports.....	22
7.6	Conducted emission, Wired network ports.....	23
8	Immunity tests description and results	24
8.1	Radio frequency electromagnetic field (80 MHz to 6 000 MHz).....	24
8.2	Electrostatic discharge	26
8.3	Fast transients, common mode	28
8.4	Radio frequency, common mode	29
8.5	Transients and surges in the vehicular environment	31
8.6	Voltage dips and interruptions.....	32
8.7	Surges	33
9	Measurement uncertainties	34
10	Photographs from test site	35

1 GENERAL INFORMATION

EMC emissions and immunity tests were performed on the equipment under test (EUT) in the testing laboratory of Technický skúšobný ústav Piešťany, a. s., Piešťany, Slovak Republic, accredited by the SNAS.

All tests were conducted in an environment which ensured that the measurable influence or interference (background noise) not generated by EUT, was below the threshold limits defined in the standards.

2 TEST METHODS AND CONDITIONS

Test methods used :	MPS 01/5.10 Measurement of electromagnetic compatibility
Standards :	EN 301 489-1 V2.2.3 ElectroMagnetic Compatibility (EMC) standard for radio equipment and services; Part 1: Common technical requirements EN 301 489-17 V3.2.4 ElectroMagnetic Compatibility (EMC) standard for radio equipment and services; Part 17: Specific conditions for Broadband Data Transmission Systems
Place of testing :	<input checked="" type="checkbox"/> EMC testing laboratory TSÚ Piešťany a. s. <input type="checkbox"/> Laboratory Pobedim TSÚ Piešťany, a. s. <input type="checkbox"/> on-site:
Place and date of sample delivery :	The samples were delivered to TSÚ Piešťany, a. s. on 04.06.2024 and recorded under the registration number 240500150/213/5536/4.
Start of test :	27.06.2024
End of test :	16.08.2024
Test procedure deviations :	Without test procedure deviation.
Tests conditions and results :	see chapters 3, 4, 5, 7, 8

2.1 Environmental conditions

Temperature :	21 - 24 °C
Relative humidity :	34 - 38 %
Atmospheric pressure :	1001 - 1025 hPa

Note: Actual values are valid for all tests. Exact actual values during ESD test are provided in chapter 8.2.

3 SUMMARY OF TESTS AND TEST RESULTS

Possible test case verdicts:

- test not applicable.....: N/A
- test not required.....: N/R
- test object does meet the requirement.....: PASS
- test object does not meet the requirement.....: FAIL

The tests were performed in accordance with the requirements of standards 301 489-17 V3.2.4 and referenced EN 301 489-1 V2.2.3. Basic standards referenced by EN 301 489-1 V2.2.3 as follows:

Harmonized Standard ETSI EN 301 489-17				
Classification of EUT: Radio equipment for fixed use.				
Emissions				
Clause No. of EN 301 489-1	Test Description	Referenced standard	Test Result	Condition
8.2	Radiated emission, Enclosure of ancillary equipment	EN 55032	PASS	Class B Equipment intended primarily for use in an industrial environment shall meet the Class A limits
8.3	Conducted emission, DC power input/output ports	EN 55032	N/A (Note1)	Only where equipment has DC power input and/or output ports with a cable length greater than 3 m or from a vehicle power supply
8.4	Conducted emission, AC mains input/output ports	EN 55032	PASS	Class B Equipment intended primarily for use in an industrial environment shall meet the Class A limits
8.5	Harmonic current emissions, AC mains input port	EN 61000-3-2 EN 61000-3-12	PASS	EN 61000-3-2 Class A Equipment with input current ≤ 16 A per phase. Limits are not specified for equipment with a rated power of 75 W or less
8.6	Voltage fluctuations and flicker, AC mains input ports	EN 61000-3-3 EN 61000-3-11	PASS	EN 61000-3-3 Equipment with input current ≤ 16 A per phase
8.7	Conducted emission, Wired network ports	EN 55032	N/A (Note3)	Class B Only where equipment has wired network ports
Immunity				
Clause No. of EN 301 489-1	Test Description	Referenced standard	Test Result	Condition
9.2	Radio frequency electromagnetic field (80 MHz to 6 000 MHz)	EN 61000-4-3	PASS	---
9.3	Electrostatic discharge	EN 61000-4-2	PASS	---
9.4	Fast transients, common mode	EN 61000-4-4	PASS	---
9.5	Radio frequency, common mode	EN 61000-4-6	PASS	---
9.6	Transients and surges in the vehicular environment	ISO 7637-2	N/A (Note2)	Only where equipment is connected to vehicle power supply
9.7	Voltage dips and interruptions	EN 61000-4-11	PASS	---
9.8	Surges	EN 61000-4-5	PASS	---
Note 1: The EUT is powered from AC mains.				
Note 2: The EUT is not intended for vehicular environment.				
Note 3: The EUT does not utilize any wired network ports.				

4 PERFORMANCE CRITERIA

The performance criteria are used to make an assessment whether radio equipment passes or fails immunity tests.

The test results shall be classified in terms of the loss of function or degradation of performance of the equipment under test, relative to a performance level defined by its manufacturer or the requestor of the test, or agreed between the manufacturer and the purchaser of the product.

- based on the used product standard
 based on the declaration of the manufacturer, requestor or purchaser

Performance criteria defined in clause 6 of EN 301 489-1 V2.2.3:

Performance criterion		
1	Performance criterion for continuous phenomena	During the test, the equipment shall: <ul style="list-style-type: none"> • continue to operate as intended; • not unintentionally transmit; • not unintentionally change its operating state; • not unintentionally change critical stored data.
2	Performance criterion for transient phenomena	For all ports and transient phenomena with the exception described below, the following applies: <ul style="list-style-type: none"> • The application of the transient phenomena shall not result in a change of the mode of operation (e.g. unintended transmission) or the loss of critical stored data. • After application of the transient phenomena, the equipment shall operate as intended. For surges applied to symmetrically operated wired network ports intended to be connected directly to outdoor lines the following criteria applies: <ul style="list-style-type: none"> • For products with only one symmetrical port intended for connection to outdoor lines, loss of function is allowed, provided the function is self-recoverable, or can be otherwise restored. Information stored in non-volatile memory, or protected by a battery backup, shall not be lost. • For products with more than one symmetrical port intended for connection to outdoor lines, loss of function on the port under test is allowed, provided the function is self-recoverable. Information stored in non-volatile memory, or protected by a battery backup, shall not be lost.

Performance criteria defined in clause 6.2 of EN 301 489-17 V3.2.4 apply:

performance criterion A for immunity tests with phenomena of a continuous nature;

performance criterion B for immunity tests with phenomena of a transient nature;

performance criterion C for immunity tests with power interruptions exceeding a certain time.

Criterion	During test	After test
A	Shall operate as intended. Shall be no loss of function. Shall be no unintentional transmissions.	Shall operate as intended. Shall be no degradation of performance. Shall be no loss of function. Shall be no loss of critical stored data.
B	May cause a loss of function.	Functions shall be self-recoverable. Shall operate as intended after recovering. Shall be no loss of critical stored data.
C	May cause a loss of function.	Functions shall be recoverable by the operator. Shall operate as intended after recovering. Shall be no loss of critical stored data.

NOTE: Operate as intended during the test allows a level of degradation in accordance with clause 6.2.2

Minimum performance level: For equipment that supports a PER or FER, the minimum performance level shall be a PER or FER less than or equal to 10 %.

For equipment that does not support a PER or a FER, the minimum performance level shall be no loss of the wireless transmission function needed for the intended use of the equipment.

The results of applicable immunity tests based on these criteria are given in respective chapters.

5 EQUIPMENT UNDER TEST

5.1 Description of EUT

Prototype:

Production version:

Manufacturer: Trivolt s.r.o.
Dialničná cesta 22B
903 01 Senec
Slovak Republic

Product name: Thermostat for electric floor heating

Model: TR-210

Serial number: --- (not stated on the samples)

Number of test samples: 2 pcs.

Description: TR-210 is an electronic thermostat designed for electric floor heating. The thermostat allows you to set a comfortable temperature in the room and at the same time using the floor sensor to check and manage the maximum floor temperature. The air sensor is built right on the bottom side of the thermostat and an external NTC floor sensor is supplied as a standard accessory and is included in the thermostat package. The thermostat uses WiFi connection for remote control.

Tested sample description: Power rating: 230 V AC, 50 Hz, <1,5 W
Output: 230 V AC, 16 A max. load

Max. internal clock frequency: higher than 108 MHz

EUT functional temperature range: 0 to +45 °C

RF operational frequencies:

Bluetooth/BLE:
2402 – 2480 MHz, output power < 10 dBm, internal antenna

Wi-Fi 2.4 GHz:
2412 – 2472 MHz, output power < 20 dBm, internal antenna

Deviations from the Basic
EMC standards: none

5.2 Software and firmware

The equipment under test was operating during the measurement under the following conditions:
The EUT was powered from 230 V AC mains. The EUT was tested with load provided by manufacturer.
The WiFi and BLE functions were enabled during the testing.

5.3 Test modes

The EUT was tested with ancillary equipment (AE) as follows:

AE1: Heating mat, model: TR-2P-10, manufacturer: Trivolt s.r.o, Slovak Republic (provided by manufacturer for testing)

AE2: Smartphone, model: SM-A127F/DSN (Galaxy A12), S/N: R58RB03WEHV, manufacturer: Samsung Electronics Co., Ltd. (laboratory equipment)

5.4 Input / output ports

Any connection point on equipment intended for connection of cables to or from that equipment is considered as a port:



List of EUT ports:

- AC power input port, cable length <3 m
- AC power output port, cable length <3 m
- Signal/control port (NTC), cable length <3 m

5.5 RF exclusion bands

The frequencies on which the EUT is intended to operate shall be excluded from the conducted and radiated RF emission and immunity tests.

The exclusion bands according to EN 301 489-1, EN 301 489-17 apply to the EUT.

6 TEST EQUIPMENT USED

Measurement of emissions						
Used eq.	Name	Manufacturer	Type	S/N	Registration no.	Date of calibration validity
<input checked="" type="checkbox"/>	EMI test receiver	Rohde & Schwarz	ESR7	1316.30003K07	540-316-022	23.06.2025
<input checked="" type="checkbox"/>	LISN type V	PMM Italy	PMM L3-32	122WT50407	540-316-018	24.04.2025
<input type="checkbox"/>	LISN type V	Hameg	HM6050-2	025880024	540-316-026	02.03.2025
<input type="checkbox"/>	BiConiLog Antenna	A.H. Systems	SAS-521F-2	272	540-317-097	24.08.2025
<input checked="" type="checkbox"/>	BiConiLog Antenna	ETS Lindgren	3143B	00157570	540-316-017	23.11.2024
<input checked="" type="checkbox"/>	Horn Antenna	ETS Lindgren	3119	00157903	540-316-016	16.12.2024
<input type="checkbox"/>	Three-phase network analyzer	Fluke	Fluke 435	DM9631006	130-316-85	17.05.2025
<input checked="" type="checkbox"/>	Mains network analyzer	Spitzenberger	B10	G80588	540-316-025	11.11.2024
<input checked="" type="checkbox"/>	LISN - 16A	Spitzenberger	Line - 16A	A2793 07/0 0701	540-316-023	11.11.2024
<input checked="" type="checkbox"/>	AC/ DC Power source	Spitzenberger	PAS 5000	A2793 01/0 0701	540-316-024	11.11.2024
<input checked="" type="checkbox"/>	Antenna mast	ETS Lindgren	2175	---	---	---
<input checked="" type="checkbox"/>	Turntable	ETS Lindgren	2188	---	---	---
<input checked="" type="checkbox"/>	Anechoic chamber	ETS Lindgren	FACT 3	---	---	---
<input checked="" type="checkbox"/>	Atmosphere recorder	Comet System	C4130	13900371	412-316-001	04.04.2025

Measurement of susceptibility						
Used eq.	Name	Manufacturer	Type	S/N	Registration no.	Date of calibration validity
<input type="checkbox"/>	Multifunctional test generator for transients	EM test	UCS500 N5	07430/06	540-323-77	07.07.2025
<input checked="" type="checkbox"/>	Compact NX Generator	AMETEK CTS	NX5	1824221146	540-317-091	13.03.2026
<input type="checkbox"/>	ESD Simulator	Schaffner	NSG 432	1450	540-316-019	17.08.2025
<input checked="" type="checkbox"/>	Generator - ESD NX 30.1	emtest	ESD NX 30.1	11944	540-317-098	05.03.2026
<input checked="" type="checkbox"/>	Compact simulator conducted immunity	EM test	CWS500 N1	P1315117094	540-316-001	08.08.2025
<input type="checkbox"/>	Coupling and Decoupling network	EM test	CDN M1-32A	P1326119725	540-316-002	---
<input checked="" type="checkbox"/>	Coupling and Decoupling network	EM test	CDN M2/M3	P1343125199	540-316-003	---
<input type="checkbox"/>	Coupling and Decoupling network	EM test	CDN M5-32A	P1317117980	540-316-004	---
<input type="checkbox"/>	Coupling and Decoupling network	EM test	CDN S4 USB	P1315117419	540-316-005	---
<input type="checkbox"/>	Coupling and Decoupling network	EM test	CDN AF3	P1315117307	540-316-006	---
<input type="checkbox"/>	Coupling and Decoupling network	EM test	CDN AF5	P1316117719	540-316-007	---
<input type="checkbox"/>	Coupling and Decoupling network	EM test	CDN AF8	P1318118482	540-316-008	---
<input type="checkbox"/>	Coupling and Decoupling network	EM test	CDN T4 RJ45	P1344125509	540-316-009	---
<input type="checkbox"/>	Coupling and Decoupling network	EM test	CDN S19 HDMI	P1529161237	540-316-020	---
<input type="checkbox"/>	Coupling and Decoupling network	EM test	CDN T8 RJ45	P1510151693	540-316-021	---
<input type="checkbox"/>	Coupling and Decoupling network	Schaffner	CDN 117	17395	540-323-83	---
<input type="checkbox"/>	Coupling and Decoupling network	AMETEK CTS	CNI 508N2	P1907226998	540-317-090	27.02.2025
<input checked="" type="checkbox"/>	RF Amplifier	Prana	MT-200	---	1312-1464	---
<input checked="" type="checkbox"/>	RF Amplifier	Prana	SV-40DC	---	1312-1465	---
<input checked="" type="checkbox"/>	RF Amplifier	Prana	UX-30DC	---	1312-1466	---
<input checked="" type="checkbox"/>	Attenuator 6dB	EM test	ATT 6 / 75	P1306112990	540-316-010	21.11.2024
<input checked="" type="checkbox"/>	Adapter - R100N	EM test	R100N	P1324119059	540-316-011	22.11.2024
<input checked="" type="checkbox"/>	Field Probe	PMM Italy	EP 601	511WX30645	540-316-014	22.11.2024
<input checked="" type="checkbox"/>	Signal Generator	Rohde&Schwarz	SMB100A03	180253	540-316-027	02.05.2025
<input checked="" type="checkbox"/>	AC/ DC Power source	Spitzenberger	PAS 5000	A2793 01/0 0701	540-316-024	11.11.2024
<input type="checkbox"/>	Set to measurement of immunity to the magnetic field	TSÚ Piešťany, a. s.	9.15	201501	540-317-084	---
<input type="checkbox"/>	BiConiLog Antenna	A.H. Systems	SAS-521F-2	272	540-317-097	24.08.2025
<input checked="" type="checkbox"/>	BiConiLog Antenna	ETS Lindgren	3143B	00157570	540-316-017	23.11.2024
<input checked="" type="checkbox"/>	Horn Antenna	ETS Lindgren	3119	00157903	540-316-016	16.12.2024
<input checked="" type="checkbox"/>	Antenna mast	ETS Lindgren	2175	---	---	---
<input checked="" type="checkbox"/>	Turntable	ETS Lindgren	2188	---	---	---
<input checked="" type="checkbox"/>	Anechoic chamber	ETS Lindgren	FACT 3	---	---	---
<input checked="" type="checkbox"/>	Atmosphere recorder	Comet System	C4130	13900371	412-316-001	04.04.2025

7 EMISSIONS TESTS DESCRIPTION AND RESULTS

7.1 Radiated emission, Enclosure of ancillary equipment

General description:

This test is only applicable to ancillary equipment not incorporated in the radio equipment and intended to be measured on a stand-alone basis, as declared by the manufacturer. This test shall be performed on a representative configuration of the ancillary equipment.

This test is not applicable for ancillary equipment incorporated in the radio equipment, or for ancillary equipment intended to be measured in combination with the radio equipment. In these cases the requirements of the relevant product standard for the effective use of the radio spectrum shall apply.

Product related conditions for combined testing of radio and ancillary equipment may be contained in the relevant part of ETSI EN 301 489 series.

This test assesses the level of radiated electromagnetic noise from the ancillary equipment.

Test method:

The test method shall be in accordance with CENELEC EN 55032.

Typical test setup in SAC at 3m measurement distance up to 1 GHz:

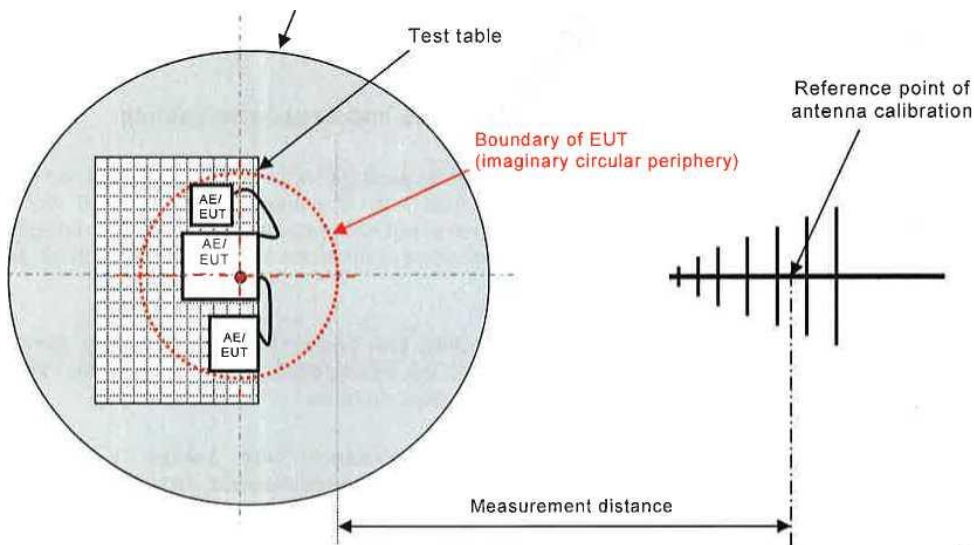
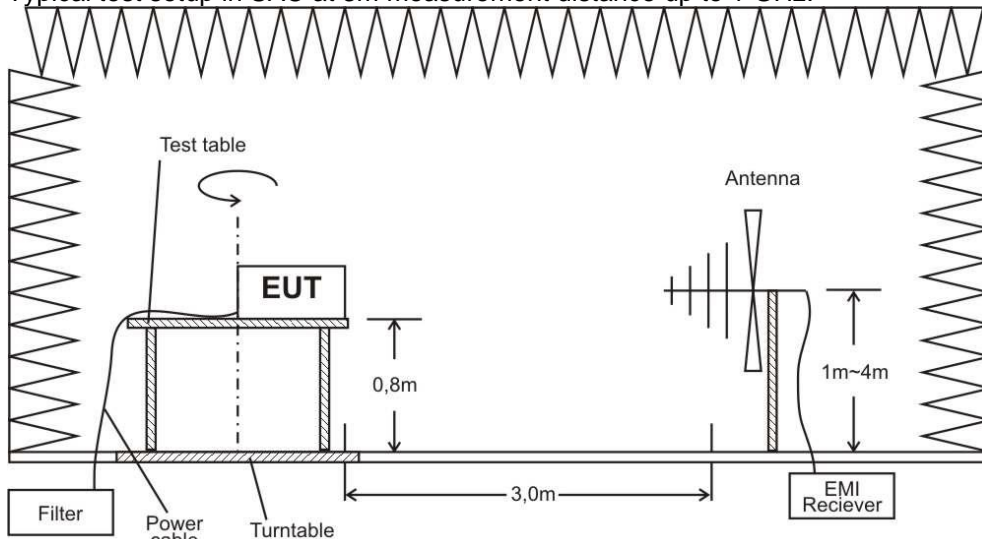

IEC

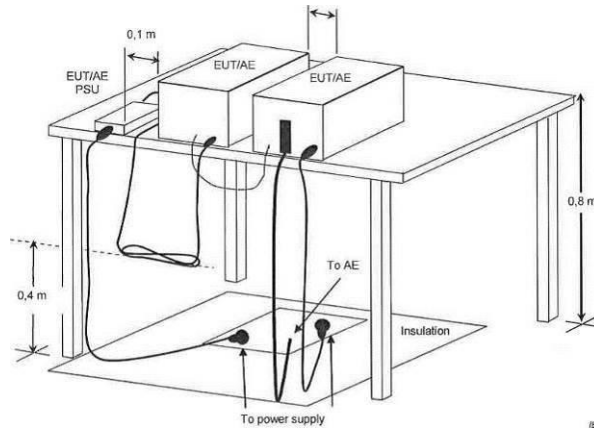

Example of measurement arrangement for table-top EUT (radiated emission measurement)

A facility validated against the FSOATS requirements shall be used for measurements above 1 GHz. An FSOATS may be a SAC/OATS with RF absorber on the RGP or a FAR.

Note: Abbreviations:
 FSOATS - Free Space Open Area Test Site
 FAR - Fully Anechoic Room
 OATS - Open Area Test Site
 SAC - Semi Anechoic Chamber

Limits:

The ancillary equipment shall meet the class B limits given in CENELEC EN 55032.

Alternatively, for ancillary equipment intended to be used exclusively in an industrial environment or telecommunication centers, the class A limits given in CENELEC EN 55032 may be used.

Requirements for radiated emissions					
Frequency range MHz	Measurement			Class A limits dB(µV/m)	Class B limits dB(µV/m)
	Facility	Distance (m)	Detector type / bandwidth		
30 to 230	OATS/SAC	3	Quasi Peak / 120 kHz	50	40
230 to 1 000				57	47
1 000 to 3 000	FSOATS	3	Average / 1 MHz	56	50
3 000 to 6 000				60	54
1 000 to 3 000			Peak / 1 MHz	76	70
3 000 to 6 000				80	74

Measurement data:

Results of tests of radio disturbance emission – frequency range from 30 MHz to 1 GHz:

Antenna polarization: **Vertical**

Scan Table

Scan Start 30.00000000 MHz
 Scan Stop 1.000000000 GHz
 Scan Type TD Scan
 Transducer Antenna 3143B new cal + cable

Detector Trace 1: Quasi Peak
 Start Stop Step Size RBW RF Atten Preamp Input
 Frequency Frequency
 30.000 MHz 1.000 GHz 30.000 kHz 120.0 kHz 10.0 dB 20.0 dB INPUT1

Peak List

Margin 30.0 dB
 Peaks 25

Trace	Frequency	Level (dBµV)	Phase	Detector	Delta Limit/dB
1	35.520000000 MHz	21.42		Quasi Peak	-18.58
1	43.470000000 MHz	25.52		Quasi Peak	-14.48
1	57.120000000 MHz	27.74		Quasi Peak	-12.26
1	60.510000000 MHz	22.34		Quasi Peak	-17.66
1	85.890000000 MHz	20.10		Quasi Peak	-19.90
1	89.340000000 MHz	23.53		Quasi Peak	-16.47
1	153.660000000 MHz	22.52		Quasi Peak	-17.48
1	179.670000000 MHz	17.24		Quasi Peak	-22.76
1	346.590000000 MHz	17.46		Quasi Peak	-29.54
1	491.850000000 MHz	20.60		Quasi Peak	-26.40
1	686.190000000 MHz	27.00		Quasi Peak	-20.00
1	951.810000000 MHz	30.68		Quasi Peak	-16.32

Scan Diagram

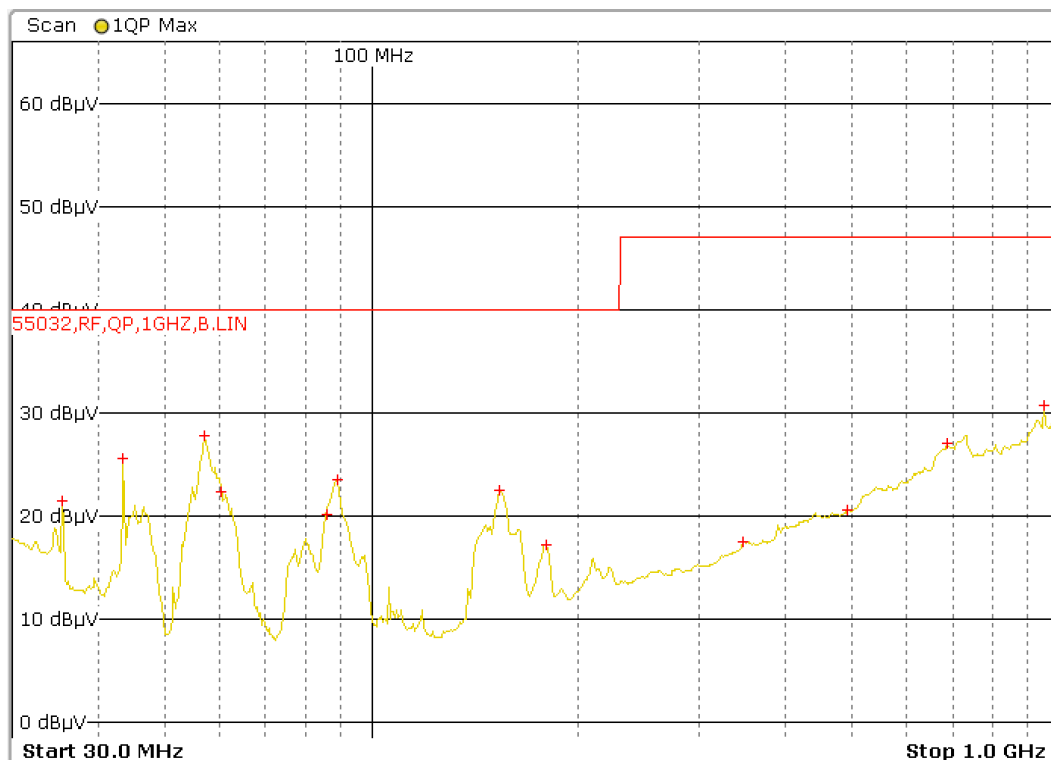

Result of test: PASS

Antenna polarization: **Horizontal**

Scan Table

Scan Start 30.00000000 MHz
Scan Stop 1.000000000 GHz
Scan Type TD Scan
Transducer Antenna 3143B new
cal + cable

Detector Trace 1: Quasi Peak
Start Stop Step Size RBW RF Atten Preamp Input
Frequency Frequency
30.000 MHz 1.000 GHz 30.000 kHz 120.0 kHz 10.0 dB 20.0 dB INPUT1

Peak List

Margin 30.0 dB
Peaks 25

Trace	Frequency	Level (dB μ V)	Phase	Detector	Delta Limit/dB
1	30.030000000 MHz	18.09		Quasi Peak	-21.91
1	57.630000000 MHz	12.78		Quasi Peak	-27.22
1	79.800000000 MHz	19.67		Quasi Peak	-20.33
1	90.840000000 MHz	27.11		Quasi Peak	-12.89
1	167.310000000 MHz	16.81		Quasi Peak	-23.19
1	180.300000000 MHz	19.04		Quasi Peak	-20.96
1	345.900000000 MHz	18.11		Quasi Peak	-28.89
1	492.330000000 MHz	21.21		Quasi Peak	-25.79
1	686.850000000 MHz	27.59		Quasi Peak	-19.41
1	951.840000000 MHz	30.37		Quasi Peak	-16.63

Scan Diagram

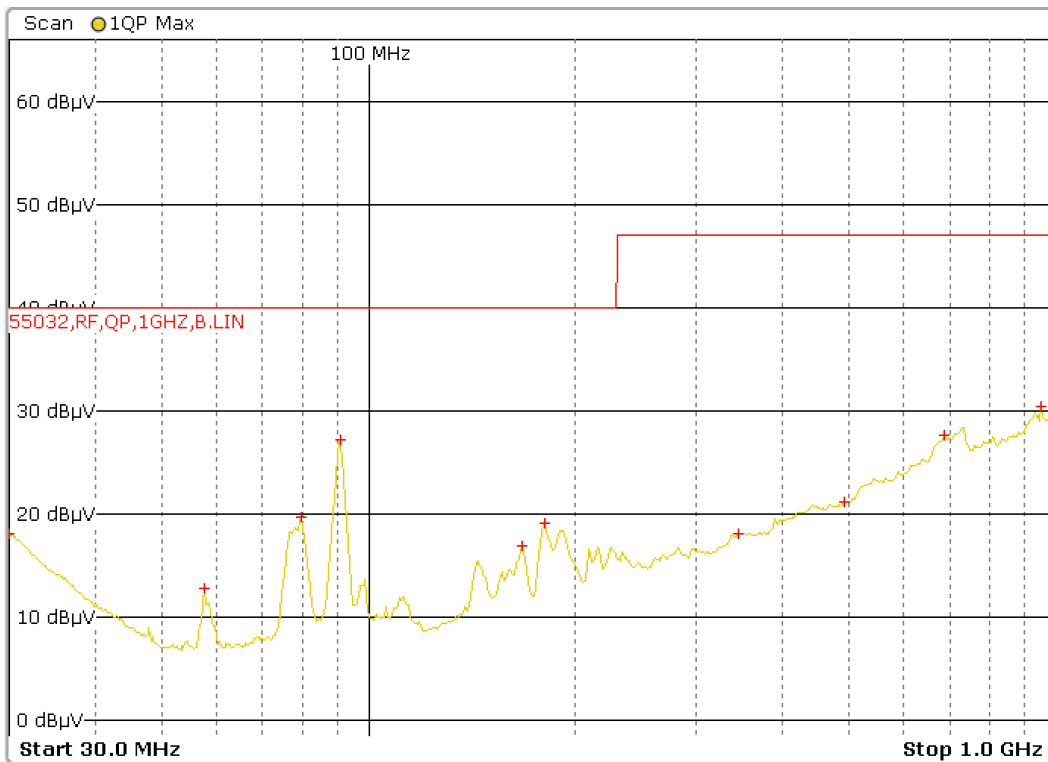

Result of test: **PASS**

Results of tests of radio disturbance emission – frequency range from 1 GHz to 6 GHz:

Antenna polarization: **Vertical**

Scan Table

Scan Start 1.00000000 GHz
 Scan Stop 6.00000000 GHz
 Scan Type TD Scan
 Transducer Antenna 3119 + cable

Detector Trace 1: Max Peak Trace 2: CISPR AV
 Start Stop Step Size RBW RF Atten Preamp Input
 Frequency Frequency Step Size
 1.000 GHz 6.000 GHz 250.000 kHz 1.0 MHz 10.0 dB 20.0 dB INPUT1

Peak List

Trace	Frequency	Level (dBµV)	Phase	Detector	Delta Limit/dB
Margin		27.0 dB			
Peaks		5			
1	1.024250000 GHz	46.64		Positive Peak	-23.36
2	1.025750000 GHz	31.67		CISPR AV	-18.33
1	1.539000000 GHz	45.16		Positive Peak	-24.84
2	1.546750000 GHz	30.74		CISPR AV	-19.26
1	1.955250000 GHz	47.58		Positive Peak	-22.42
2	1.957750000 GHz	33.32		CISPR AV	-16.68
1	2.401750000 GHz	82.26		Positive Peak	12.26
2	2.426000000 GHz	40.67		CISPR AV	-9.33
1	2.426250000 GHz	84.13		Positive Peak	14.13
2	2.480000000 GHz	39.71		CISPR AV	-10.29
1	2.480250000 GHz	82.05		Positive Peak	12.05
2	3.756750000 GHz	41.95		CISPR AV	-12.05
1	3.788250000 GHz	57.13		Positive Peak	-16.87
1	4.680250000 GHz	58.05		Positive Peak	-15.95
2	4.796000000 GHz	43.80		CISPR AV	-10.20
1	5.942250000 GHz	61.08		Positive Peak	-12.92
2	5.966500000 GHz	46.37		CISPR AV	-7.63

Scan Diagram

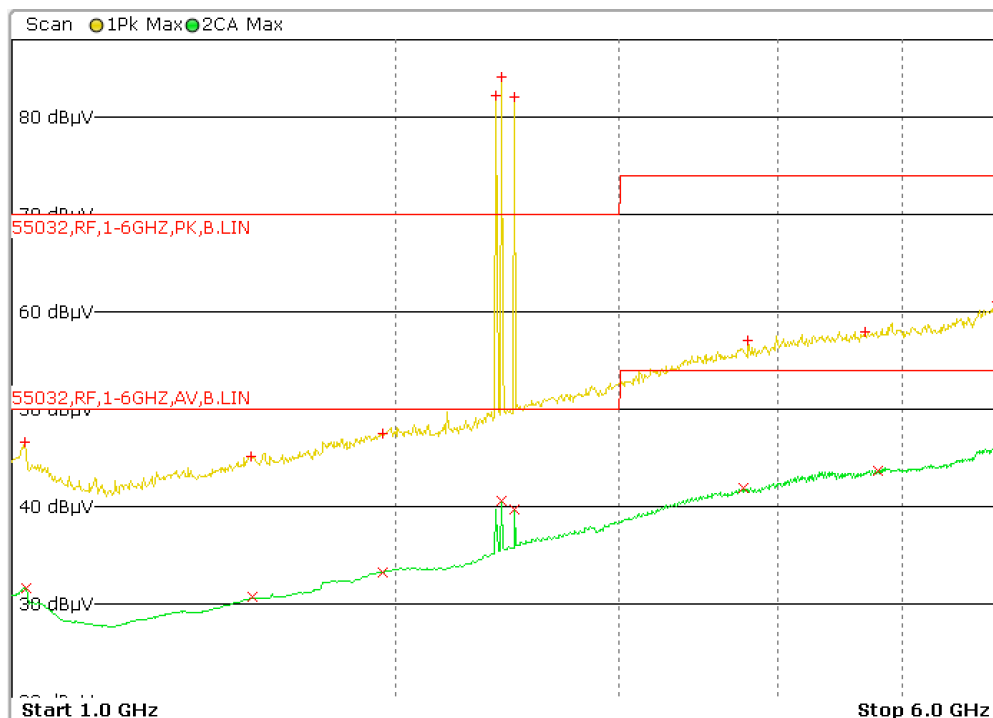

Note: Emissions in the 2.4 GHz band are part of the working frequency bands; they will be disregarded from the evaluation of results.

Result of test: PASS

Antenna polarization: **Horizontal**

Scan Table

Scan Start 1.000000000 GHz
 Scan Stop 6.000000000 GHz
 Scan Type TD Scan
 Transducer Antenna 3119 + cable

Detector Trace 1: Max Peak Trace 2: CISPR AV
Start Stop Step Size RBW RF Atten Preamp Input
Frequency Frequency
 1.000 GHz 6.000 GHz 250.000 kHz 1.0 MHz 10.0 dB 20.0 dB INPUT1

Peak List

Margin	27.0 dB	
Peaks	5	
Trace	Frequency	Level (dBµV) Phase Detector Delta Limit/dB
1	1.020750000 GHz	45.70 Positive Peak -24.30
2	1.025750000 GHz	31.66 CISPR AV -18.34
2	1.547000000 GHz	30.73 CISPR AV -19.27
1	1.552000000 GHz	45.07 Positive Peak -24.93
1	1.911250000 GHz	47.69 Positive Peak -22.31
2	1.957500000 GHz	33.32 CISPR AV -16.68
1	2.402000000 GHz	80.69 Positive Peak 10.69
1	2.426000000 GHz	81.42 Positive Peak 11.42
2	2.426000000 GHz	39.54 CISPR AV -10.46
1	2.480000000 GHz	80.85 Positive Peak 10.85
2	2.480000000 GHz	39.52 CISPR AV -10.48
2	3.756500000 GHz	41.95 CISPR AV -12.05
1	3.786750000 GHz	56.57 Positive Peak -17.43
1	4.413000000 GHz	58.19 Positive Peak -15.81
2	4.796000000 GHz	43.79 CISPR AV -10.21
1	5.890250000 GHz	60.55 Positive Peak -13.45
2	5.966500000 GHz	46.37 CISPR AV -7.63

Scan Diagram

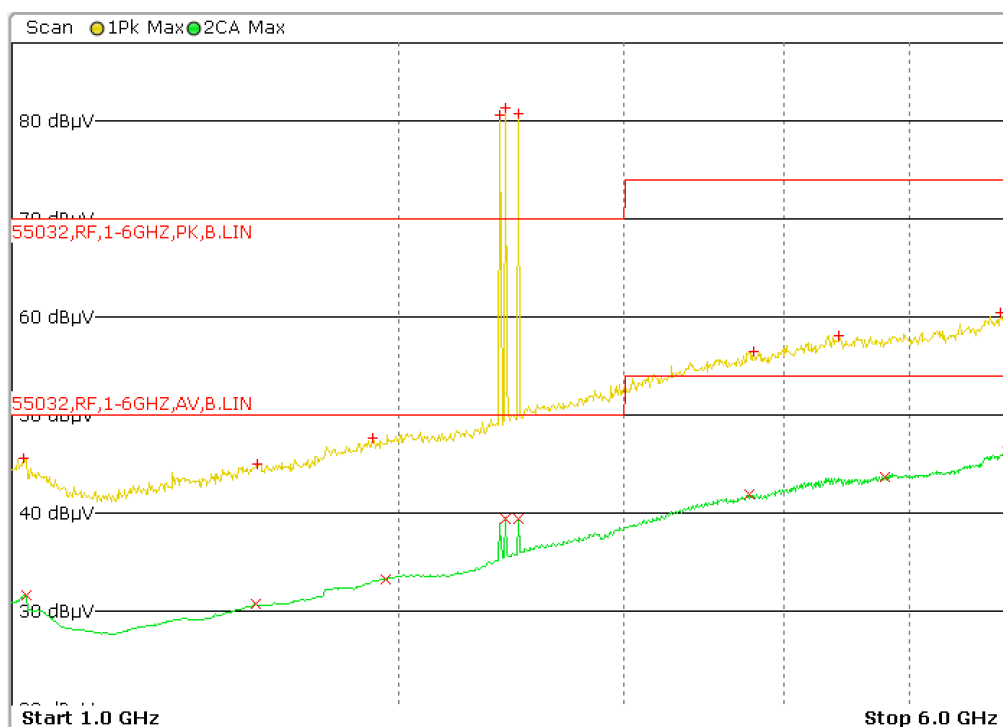

Note: Emissions in the 2.4 GHz band are part of the working frequency bands; they will be disregarded from the evaluation of results.

Result of test: PASS

7.2 Conducted emission, DC power input/output ports

General description:

This test is applicable for radio equipment and ancillary equipment for fixed use that may have DC cables longer than 3 m (manufacturer's declaration) and for vehicular use irrespective of cable length.

If the DC power cable of the radio and/or the ancillary equipment is less than or equal to 3 m in length, and intended for direct connection to a dedicated AC/DC power supply, then the measurement shall be performed on the AC power input port of that power supply. If the DC power cable is longer than 3 m, then the measurement shall additionally be performed on the DC power port of the radio and/or ancillary equipment.

If the DC power cable between the mobile radio and/or ancillary equipment and the dedicated DC/DC power converter is less than or equal to 3 m in length, then the measurement can be limited to the DC power input port of that power converter only. If this DC power cable is longer than 3 m, then the measurement shall additionally be performed on the DC power port of the mobile radio and/or ancillary equipment.

This test shall be performed on a representative configuration of the radio equipment, the associated ancillary equipment, or a representative configuration of the combination of radio and ancillary equipment. This test assesses the level of internally generated electrical noise present on the DC power input/output ports.

Test method:

For all radio equipment other than intended to be connected to the vehicle's onboard DC mains, the test method for AC mains power port specified in CENELEC EN 55032 shall be used.

The measurement frequency range extends from 150 kHz to 30 MHz. When the EUT is a transmitter operating at frequencies below 30 MHz, then the exclusion band for transmitters applies for measurements in the transmit mode of operation.

For emission measurements on DC output ports the relevant port shall be connected via an AMN/AN to a load drawing the rated current of the source.

Limits:

The equipment shall meet the class B limits given in the clause 8.3 of EN 301 489-1.

Alternatively, for ancillary equipment intended to be used exclusively in an industrial environment or telecommunication centres, the class A limits given in the clause 8.3 of EN 301 489-1 may be used.

Frequency range MHz	Coupling device	Detector type / bandwidth	Limits dB(μ V)
0.15 to 0.50	AMN/AN	Quasi Peak / 9 kHz	79
0.50 to 30			73
0.15 to 0.50	AMN/AN	Average / 9 kHz	66
0.50 to 30			60

Measurement data:

Test not applicable to the EUT.

7.3 Conducted emission, AC mains input/output ports

General description:

This test is applicable for radio equipment and/or ancillary equipment for fixed use powered by the AC mains.

This test shall be performed on a representative configuration of the radio equipment, the associated ancillary equipment, or a representative configuration of the combination of radio and ancillary equipment. This test assesses the level of internally generated electrical noise present on the AC power input/output ports.

Test method:

The test method shall be in accordance with CENELEC EN 55032 and the Artificial Mains Networks (AMNs) shall be connected to the AC mains power source.

The measurement frequency range extends from 150 kHz to 30 MHz. When the EUT is a transmitter operating at frequencies below 30 MHz, then the exclusion band for transmitters applies for measurements in the transmit mode of operation.

For emission measurements on AC output ports of the EUT the relevant port shall be connected via an AMN to a load drawing the rated current of the source. In case where the AC output port is directly connected (or via a circuit breaker) to the AC power input port of the EUT the AC power output port need not to be tested.

Typical test setup:

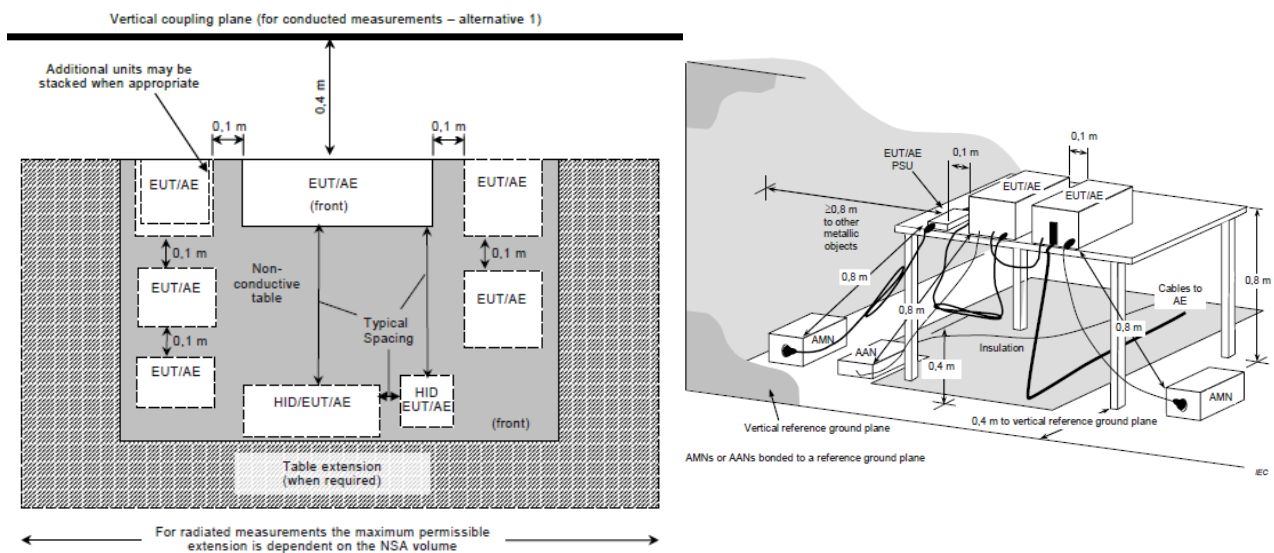

Limits:

The equipment shall meet the class B limits given in CENELEC EN 55032.

Alternatively, for ancillary equipment intended to be used exclusively in an industrial environment or telecommunication centers, the class A limits given in CENELEC EN 55032 may be used.

Frequency range MHz	Coupling device	Detector type / bandwidth	Class A limits dB(μV)	Class B limits dB(μV)
0.15 to 0.50	AMN	Quasi Peak / 9 kHz	79	66 to 56
0.50 to 5			73	56
5 to 30			73	60
0.15 to 0.50	AMN	Average / 9 kHz	66	56 to 46
0.50 to 5			60	46
5 to 30			60	50

Measurement data:

Results of tests of conducted emission, AC mains – frequency range from 150 kHz to 30 MHz:

Phase: L

Scan Table

Scan Start 150.00000000 kHz
 Scan Stop 30.00000000 MHz
 Scan Type TD Scan
 Transducer PMM L3-32
 L1(16).TDF

Detector Trace 1: Quasi Peak Trace 2: CISPR AV
 Start Stop Step Size RBW RF Atten Preamp Input
 Frequency Frequency
 150.000 kHz 30.000 MHz 2.250 kHz 9.0 kHz 10.0 dB 20.0 dB INPUT1

Peak List

Margin 25.0 dB
 Peaks 25

Trace	Frequency	Level (dBµV)	Phase	Detector	Delta Limit/dB
2	233.250000000 kHz	28.31		CISPR AV	-24.02
2	325.500000000 kHz	34.57		CISPR AV	-15.00
1	345.750000000 kHz	38.39		Quasi Peak	-20.67
1	460.500000000 kHz	47.85		Quasi Peak	-8.83
2	487.500000000 kHz	40.08		CISPR AV	-6.13
1	858.750000000 kHz	42.28		Quasi Peak	-13.72
2	858.750000000 kHz	38.19		CISPR AV	-7.81
1	903.750000000 kHz	43.28		Quasi Peak	-12.72
2	903.750000000 kHz	39.11		CISPR AV	-6.89
1	2.109750000 MHz	42.35		Quasi Peak	-13.65
2	2.109750000 MHz	37.39		CISPR AV	-8.61
2	2.154750000 MHz	38.23		CISPR AV	-7.77
1	2.177250000 MHz	43.05		Quasi Peak	-12.95
1	3.336000000 MHz	40.47		Quasi Peak	-15.53
2	3.336000000 MHz	35.64		CISPR AV	-10.36

Scan Diagram

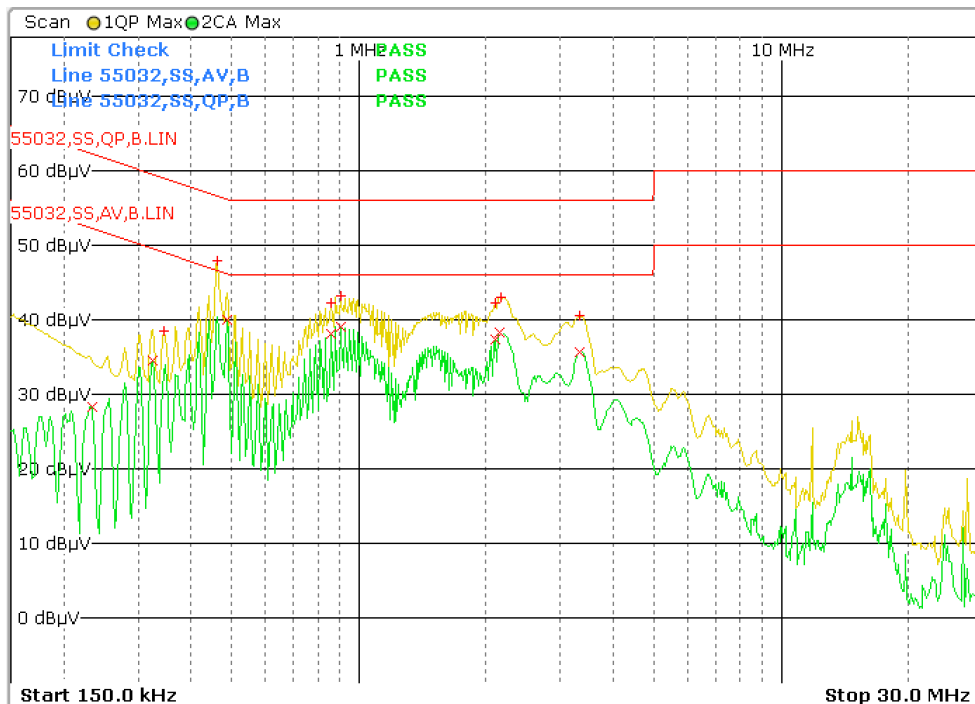

Result of test: PASS

Neutral: N

Scan Table

Scan Start 150.00000000 kHz
Scan Stop 30.00000000 MHz
Scan Type TD Scan
Transducer PMM L3-32
N(16).TDF

Detector Trace 1: Quasi Peak Trace 2: CISPR AV
Start Stop Step Size RBW RF Atten Preamp Input
Frequency Frequency
150.000 kHz 30.000 MHz 2.250 kHz 9.0 kHz 10.0 dB 20.0 dB INPUT1

Peak List

Margin 25.0 dB
Peaks 25

Trace	Frequency	Level (dBµV)	Phase	Detector	Delta Limit/dB
1	152.250000000 kHz	41.90		Quasi Peak	-23.98
2	231.000000000 kHz	34.13		CISPR AV	-18.28
1	325.500000000 kHz	41.43		Quasi Peak	-18.14
2	325.500000000 kHz	38.19		CISPR AV	-11.38
1	460.500000000 kHz	49.13		Quasi Peak	-7.55
2	460.500000000 kHz	42.38		CISPR AV	-4.30
1	858.750000000 kHz	43.32		Quasi Peak	-12.68
2	858.750000000 kHz	39.45		CISPR AV	-6.55
2	881.250000000 kHz	39.98		CISPR AV	-6.02
1	903.750000000 kHz	44.02		Quasi Peak	-11.98
1	2.112000000 MHz	43.25		Quasi Peak	-12.75
2	2.112000000 MHz	38.46		CISPR AV	-7.54
2	2.157000000 MHz	38.89		CISPR AV	-7.11
1	2.179500000 MHz	43.81		Quasi Peak	-12.19
2	3.340500000 MHz	35.42		CISPR AV	-10.58
1	3.952500000 MHz	44.97		Quasi Peak	-11.03
2	11.854500000 MHz	25.33		CISPR AV	-24.67
1	11.856750000 MHz	40.27		Quasi Peak	-19.73

Scan Diagram

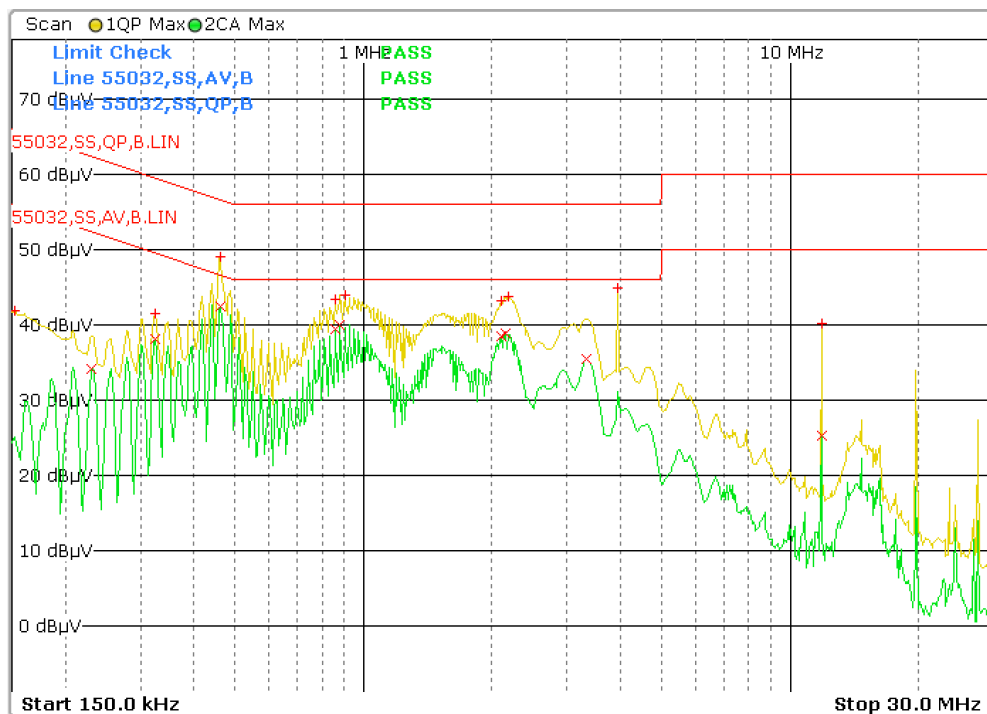

Result of test: PASS

TR: 240500150/4/EMC
18 / 36

7.4 Harmonic current emissions, AC mains input port

General description:

The appropriate requirements of CENELEC EN 61000-3-2/A1 for harmonic current emission apply for equipment with an input current up to and including 16A per phase. For equipment with an input current of greater than 16A per phase CENELEC EN 61000-3-12 applies.

Test method:

The test procedure as described in CENELEC EN 61000-3-2 or EN 61000-3-12 if applicable shall be used.

Limits:

For the purpose of harmonic current limitation, the equipment is classified according EN 61000-3-2 as follows:

Class A:

- balanced three-phase equipment; household appliances, excluding equipment identified as Class D; tools, excluding portable tools; dimmers for incandescent lamps; audio equipment.

Equipment not specified in one of the three other classes shall be considered as Class A equipment.

Class B:

- portable tools; arc welding equipment which is not professional equipment.

Class C:

- lighting equipment.

Class D:

Equipment having a specified power less than or equal to 600 W, of the following types:

- personal computers and personal computer monitors;

Limits defined in chapter 7 of EN 61000-3-2 or, for the EUT of input current over 16 A per phase limits in chapter 5 of EN 61000-3-12, applies

Limits for Class A equipment	
Harmonics order no.	Max. permissible harmonics current (A)
Odd harmonics	
3	2.30
5	1.14
7	0.77
9	0.4
11	0.33
13	0.21
15<=n<=39	0.15x15/n
Even harmonics	
2	1.08
4	0.43
6	0.30
8<=n<=40	0.23x8/n

Measurement data:

Tabular overview:

Spitzenberger & Spies GmbH & Co. KG
Viechtach

Name:		Serial no:	
Department:	317	Operating modes:	normal
Company:	TSU	Comment1:	--
Test report no:	1	Comment2:	--
Device:		Comment3:	--
Specimen:		Comment4:	--
Manufacturer:		Date:	14.08.2024
Type:		Test date:	14.08.2024

Maximum RMS current and corresponding values in timewindow 10:

Voltage:	230.86 Vrms	THD=0.00 %	THV=0.011 V	POHV=0.006 V	PWHD=0.01 %
Current:	0.741 Arms	THD=1.76 %	THC=0.013 A	POHC=0.005 A	PWHD=4.47 %
Power:	171.0 W	P1=171.0 W	171.0 VA		
Power factor:	1.000	CosPhi1: 1.000			

Test conditions: EN 61000-3-2:2014, f=50 Hz, Phase=L1, Range=4.00 A
Time window=10/12 (200ms), Grouping (>2nd harm.)=on
No Ztest selected
harmonic currents < 0.6 % of I or < 5 mA are disregard for calc. of THD, THC, POHC, PWHD

HARMONIC ANALYSIS: Test PASS
Tobs = entire measurement; POHC: avg=0.00 A, limits=0.25 A
lavg=0.738 Arms

Ha	Entire measurement (2.5 min = 750 time windows)							Worst 2.5 min		Average		P A S S	F A I L
	Maximum	Window	EN61000-3-2 Class A	Margin in MaxWin	100 to 150%	150 to 200%	Ex- ceeded	100 to 150%	Ex- ceeded	Value	Ex- ceeded		
DC	0.0138 A	299	--	--	0	0	0	n.e.	n.e.	0.0135 A	0	--	
1	0.7407 A	10	--	--	0	0	0	n.e.	n.e.	0.7380 A	0	X	
2	0.0009 A	1	1.0800 A	-99.9 %	0	0	0	n.e.	n.e.	0.0005 A	0	X	
3	0.0050 A	1	2.3000 A	-99.8 %	0	0	0	n.e.	n.e.	0.0047 A	0	X	
4	0.0004 A	571	0.4300 A	-99.9 %	0	0	0	n.e.	n.e.	0.0004 A	0	X	
5	0.0047 A	45	1.1400 A	-99.6 %	0	0	0	n.e.	n.e.	0.0045 A	0	X	
6	0.0002 A	346	0.3000 A	-99.9 %	0	0	0	n.e.	n.e.	0.0002 A	0	X	
7	0.0046 A	4	0.7700 A	-99.4 %	0	0	0	n.e.	n.e.	0.0044 A	0	X	
8	0.0003 A	536	0.2300 A	-99.9 %	0	0	0	n.e.	n.e.	0.0003 A	0	X	
9	0.0043 A	162	0.4000 A	-98.9 %	0	0	0	n.e.	n.e.	0.0042 A	0	X	
10	0.0003 A	1	0.1840 A	-99.8 %	0	0	0	n.e.	n.e.	0.0003 A	0	X	
11	0.0041 A	10	0.3300 A	-98.8 %	0	0	0	n.e.	n.e.	0.0040 A	0	X	
12	0.0002 A	459	0.1533 A	-99.9 %	0	0	0	n.e.	n.e.	0.0002 A	0	X	
13	0.0038 A	1	0.2100 A	-98.2 %	0	0	0	n.e.	n.e.	0.0037 A	0	X	
14	0.0003 A	602	0.1314 A	-99.8 %	0	0	0	n.e.	n.e.	0.0002 A	0	X	
15	0.0035 A	198	0.1500 A	-97.7 %	0	0	0	n.e.	n.e.	0.0034 A	0	X	
16	0.0003 A	1	0.1150 A	-99.8 %	0	0	0	n.e.	n.e.	0.0002 A	0	X	
17	0.0032 A	6	0.1324 A	-97.6 %	0	0	0	n.e.	n.e.	0.0031 A	0	X	
18	0.0002 A	347	0.1022 A	-99.8 %	0	0	0	n.e.	n.e.	0.0002 A	0	X	
19	0.0030 A	1	0.1184 A	-97.5 %	0	0	0	n.e.	n.e.	0.0028 A	0	X	
20	0.0002 A	124	0.0920 A	-99.7 %	0	0	0	n.e.	n.e.	0.0002 A	0	X	
21	0.0026 A	1	0.1071 A	-97.5 %	0	0	0	n.e.	n.e.	0.0025 A	0	X	
22	0.0002 A	164	0.0836 A	-99.7 %	0	0	0	n.e.	n.e.	0.0002 A	0	X	
23	0.0023 A	121	0.0978 A	-97.7 %	0	0	0	n.e.	n.e.	0.0022 A	0	X	
24	0.0002 A	195	0.0767 A	-99.7 %	0	0	0	n.e.	n.e.	0.0002 A	0	X	
25	0.0020 A	9	0.0900 A	-97.8 %	0	0	0	n.e.	n.e.	0.0019 A	0	X	
26	0.0002 A	1	0.0708 A	-99.7 %	0	0	0	n.e.	n.e.	0.0002 A	0	X	
27	0.0016 A	42	0.0833 A	-98.0 %	0	0	0	n.e.	n.e.	0.0016 A	0	X	
28	0.0002 A	83	0.0657 A	-99.7 %	0	0	0	n.e.	n.e.	0.0002 A	0	X	
29	0.0014 A	1	0.0776 A	-98.2 %	0	0	0	n.e.	n.e.	0.0013 A	0	X	
30	0.0002 A	700	0.0613 A	-99.7 %	0	0	0	n.e.	n.e.	0.0002 A	0	X	
31	0.0011 A	11	0.0726 A	-98.5 %	0	0	0	n.e.	n.e.	0.0011 A	0	X	
32	0.0002 A	570	0.0575 A	-99.7 %	0	0	0	n.e.	n.e.	0.0002 A	0	X	
33	0.0009 A	496	0.0682 A	-98.7 %	0	0	0	n.e.	n.e.	0.0008 A	0	X	
34	0.0002 A	138	0.0541 A	-99.6 %	0	0	0	n.e.	n.e.	0.0002 A	0	X	
35	0.0006 A	193	0.0643 A	-99.0 %	0	0	0	n.e.	n.e.	0.0006 A	0	X	
36	0.0002 A	1	0.0511 A	-99.6 %	0	0	0	n.e.	n.e.	0.0002 A	0	X	
37	0.0005 A	376	0.0608 A	-99.2 %	0	0	0	n.e.	n.e.	0.0004 A	0	X	
38	0.0002 A	1	0.0484 A	-99.5 %	0	0	0	n.e.	n.e.	0.0002 A	0	X	
39	0.0003 A	1	0.0577 A	-99.4 %	0	0	0	n.e.	n.e.	0.0003 A	0	X	
40	0.0002 A	544	0.0460 A	-99.6 %	0	0	0	n.e.	n.e.	0.0002 A	0	X	

■ average value < 0.6 % of lavg or < 5 mA n.e. = not evaluated

Graphical overview:

Spitzenberger & Spies GmbH & Co. KG
Viechtach

Name:		Serial no:	
Department:	317	Operating modes:	normal
Company:	TSU	Comment1:	--
Test report no:	1	Comment2:	--
Device:		Comment3:	--
Specimen:		Comment4:	--
Manufacturer:		Date:	14.08.2024
Type:		Test date:	14.08.2024

Voltage:	230.86 Vrms	THD=0.00 %	THV=0.011 V	POHV=0.005 V	PWHD=0.01 %
Current:	0.741 Arms	1.127 Apk	THD=1.76 %	THC=0.013 A	POHC=0.005 A
Power:	170.9 W	P1=170.9 W	171.0 VA		PWHD=4.47 %
Power factor:	1.000	CosPhi1: 1.000			

Test conditions: EN 61000-3-2:2014, f=50 Hz, Phase=L1, Range=4.00 A
 Time window=10/12 (200ms), Grouping (>2nd harm.)=on
 No Ztest selected
 harmonic currents < 0.6 % of I or < 5 mA are disregard for calc. of THD, THC, POHC, PWHD

Graphical Harmonic Overview - EN61000-3-2 Class A

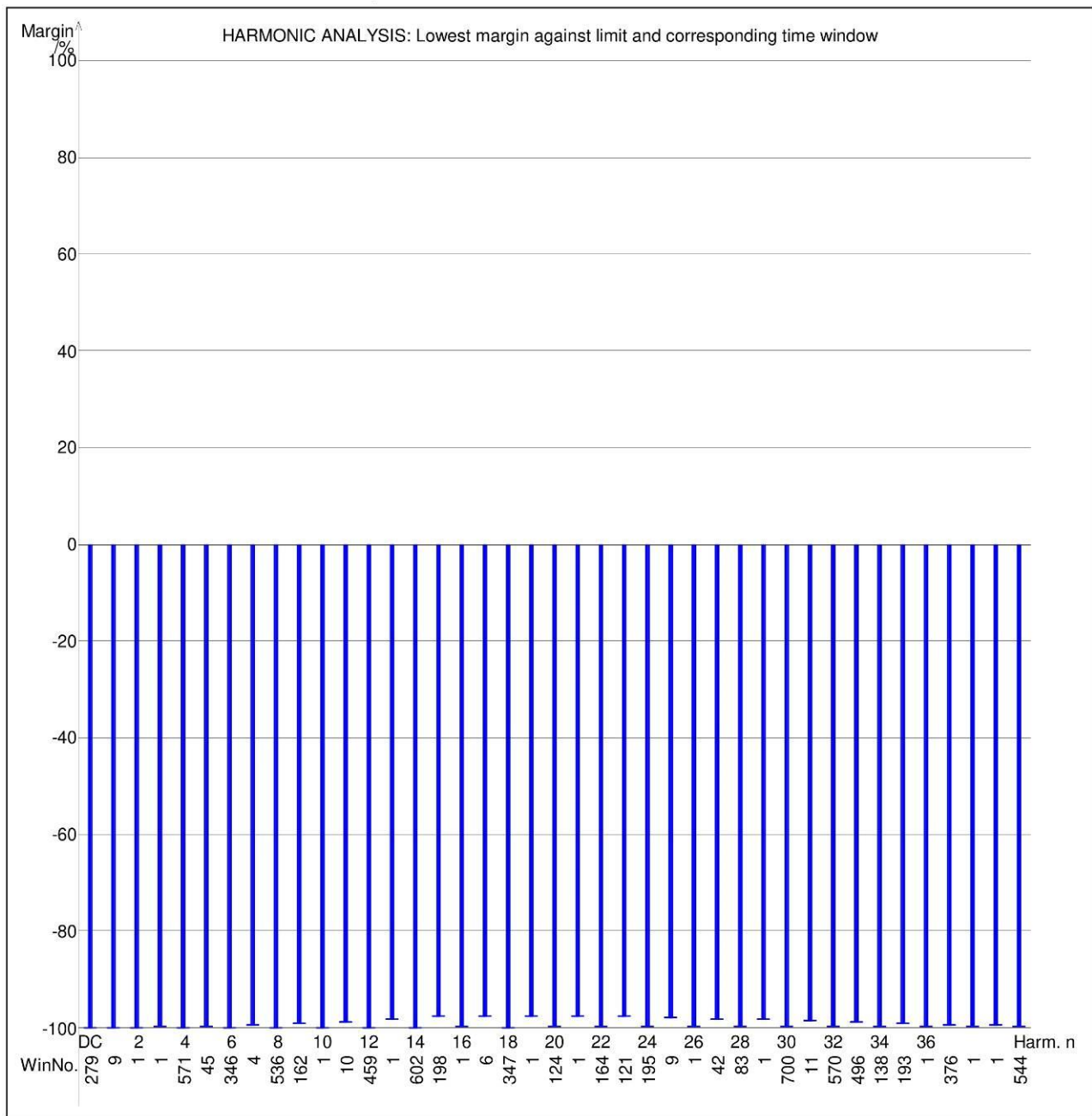

Result of test: PASS

7.5 Voltage fluctuations and flicker, AC mains input ports

General description:

The appropriate requirements of CENELEC EN 61000-3-3 for voltage fluctuations and flicker apply for equipment with an input current up to and including 16A per phase, if no conditional connection is needed. Where a conditional connection is required then the requirements of CENELEC EN 61000-3-11 shall apply. For equipment with an input current of greater than 16A up to and including 75A per phase CENELEC EN 61000-3-11 applies.

Test method:

All types of voltage fluctuations may be assessed by direct measurement using a flickermeter which complies with the specification given in IEC 61000-4-15:2010. This is the reference method for application of the limits.

Tests to prove the compliance of the equipment with the limits shall be made using the test conditions defined in chapter 6 of EN 61000-3-3 and EN 61000-3-11 if applicable.

Limits:

Limits defined in chapter 5 of EN 61000-3-3 or, for the EUT of input current over 16 A per phase or/and where conditional connection is needed limits defined in chapter 5 of EN 61000-3-12, applies.

Measurement data:

Spitzenberger & Spies GmbH & Co. KG
Viechtach

Name:		Serial no:	
Department:	317	Operating modes:	normal
Company:	TSU	Comment1:	--
Test report no:	1	Comment2:	--
Device:		Comment3:	--
Specimen:		Comment4:	--
Manufacturer:		Date:	14.08.2024
Type:		Test date:	14.08.2024

Test conditions: EN 61000-3-3:2013 / 230 V / 50 Hz / Phase L1
EN 61000-4-15:2011 / Obs 12 x 1 min / Ztest (0.400+j0.250) Ohm
Ra+jXa (0.2400+j0.1500) Ohm / Rn+jXn (0.1600+j0.1000) Ohm

FLICKER: Test PASS!

Time	Pmax	Pst	Sliding Plt	Tmax [s]	dmax [%]	dc [%]	PASS	FAIL
14:31:05	0.000	0.0020	- . - - - -	0.000	+0.000	- . - - -	X	
14:32:05	0.000	0.0010	- . - - - -	0.000	+0.000	- . - - -	X	
14:33:05	0.000	0.0010	- . - - - -	0.000	+0.000	- . - - -	X	
14:34:05	0.000	0.0010	- . - - - -	0.000	+0.000	- . - - -	X	
14:35:05	0.000	0.0010	- . - - - -	0.000	+0.000	- . - - -	X	
14:36:05	0.000	0.0010	0.0013	0.000	+0.000	- . - - -	X	
14:37:05	0.000	0.0010	0.0010	0.000	+0.000	- . - - -	X	
14:38:05	0.000	0.0010	0.0010	0.000	+0.000	- . - - -	X	
14:39:05	0.000	0.0010	0.0010	0.000	+0.000	- . - - -	X	
14:40:05	0.000	0.0010	0.0010	0.000	+0.000	- . - - -	X	
14:41:05	0.000	0.0010	0.0010	0.000	+0.000	- . - - -	X	
14:42:05	0.000	0.0010	0.0010	0.000	+0.000	- . - - -	X	
Limits:		1.000	0.650	0.500	4.000	3.300		
Plt: 0.001166 (calculated over 12 periods)							X	
Evaluated: PST, PLT, Sliding PLT, dc, dmax, Tmax								

FLICKER: Source test PASS!

Time	Pmax	Pst	Sliding Plt	Tmax [s]	dmax [%]	dc [%]	PASS	FAIL
14:31:05	0.000	0.0040	- . - - - -	0.000	+0.000	- . - - -	X	
14:32:05	0.000	0.0030	- . - - - -	0.000	+0.000	- . - - -	X	
14:33:05	0.000	0.0030	- . - - - -	0.000	+0.000	- . - - -	X	
14:34:05	0.000	0.0030	- . - - - -	0.000	+0.000	- . - - -	X	
14:35:05	0.000	0.0030	- . - - - -	0.000	+0.000	- . - - -	X	
14:36:05	0.000	0.0030	- . - - - -	0.000	+0.000	- . - - -	X	
14:37:05	0.000	0.0030	- . - - - -	0.000	+0.000	- . - - -	X	
14:38:05	0.000	0.0030	- . - - - -	0.000	+0.000	- . - - -	X	
14:39:05	0.000	0.0030	- . - - - -	0.000	+0.000	- . - - -	X	
14:40:05	0.000	0.0030	- . - - - -	0.000	+0.000	- . - - -	X	
14:41:05	0.000	0.0030	- . - - - -	0.000	+0.000	- . - - -	X	
14:42:05	0.000	0.0030	- . - - - -	0.000	+0.000	- . - - -	X	
Plt: 0.003110 (calculated over 12 periods)								
Evaluated: PST <= 0.4 dmax < 20 % dmax1								

Result of test: PASS

7.6 Conducted emission, Wired network ports

General description:

This test is applicable for radio equipment and/or ancillary equipment for fixed use which have wired network ports.

This test shall be performed on a representative configuration of the radio equipment, the associated ancillary equipment, or a representative configuration of the combination of radio and ancillary equipment.

This test assesses the level of unwanted emissions present at the wired network ports.

Test method:

The test method shall be in accordance with CENELEC EN 55032.

The measurement frequency range extends from 150 kHz to 30 MHz. When the EUT is a transmitter operating at frequencies below 30 MHz, then the exclusion band for transmitters applies for measurements in the transmit mode of operation.

Limits:

The wired network ports shall meet the class B limits given in CENELEC EN 55032.

Alternatively, for equipment intended to be used exclusively in an industrial environment or telecommunication centres, the class A limits given in CENELEC EN 55032 may be used.

Frequency range MHz	Coupling device	Detector type / bandwidth	Class A limits dB(μ V)	Class B limits dB(μ V)
0.15 to 0.50	AAN	Quasi Peak / 9 kHz	97 to 87	84 to 74
0.50 to 30			87	74
0.15 to 0.50	AAN	Average / 9 kHz	84 to 74	74 to 64
0.50 to 30			74	64

Measurement data:

Test not applicable to the EUT.

8 IMMUNITY TESTS DESCRIPTION AND RESULTS

8.1 Radio frequency electromagnetic field (80 MHz to 6 000 MHz)

General description:

This test is applicable for radio equipment and associated ancillary equipment.

This test shall be performed on a representative configuration of the radio equipment, the associated ancillary equipment, or a representative configuration of the combination of radio and ancillary equipment. This test assesses the ability of the EUT to operate as intended in the presence of a radio frequency electromagnetic field disturbance.

Test method:

The test method shall be in accordance with CENELEC EN 61000-4-3.

The following requirements and evaluation of test results shall apply:

- the test level shall be 3 V/m (measured unmodulated). The test signal shall be amplitude modulated to a depth of 80 % by a sinusoidal audio signal of 1 000 Hz. If the wanted signal is modulated at 1 000 Hz, then an audio signal of 400 Hz shall be used;
- the test shall be performed over the frequency range 80 MHz to 6000 MHz with the exception of the exclusion band for transmitters, receivers and duplex transceivers, as appropriate;
- for receivers and transmitters the stepped frequency increments shall be 1 % frequency increment of the momentary used frequency;
- the dwell time of the test phenomena at each frequency shall not be less than the time necessary for the EUT to be exercised and to be able to respond.
- the frequencies selected and used during the test shall be recorded in the test report.

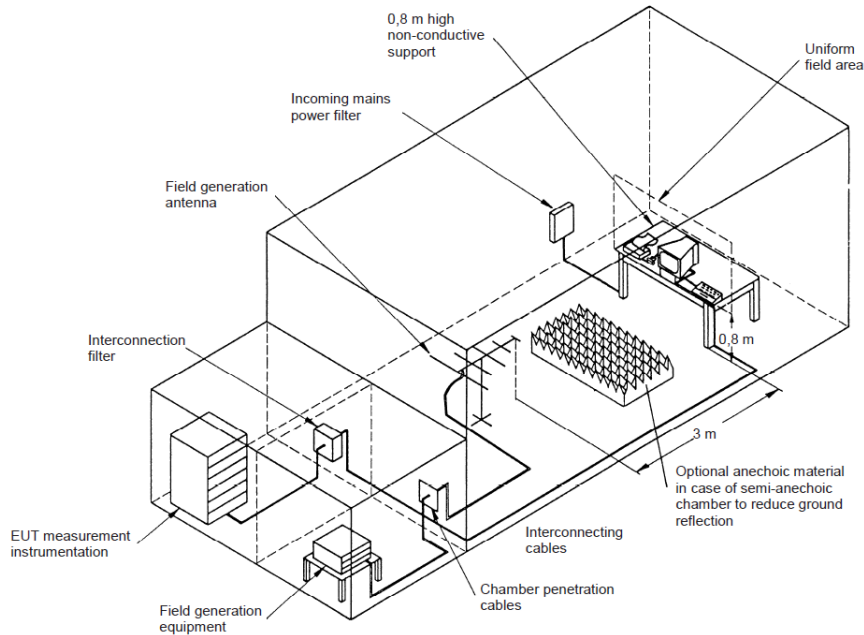

Example of suitable test facility

Performance criteria:

For transmitters the performance criteria for continuous phenomena (see chap. 5) for transmitters shall apply.

For receivers the performance criteria for continuous phenomena for receivers shall apply.

For ancillary equipment the pass/failure criteria supplied by the manufacturer shall apply, unless the ancillary equipment is tested in connection with a receiver or transmitter in which case the corresponding performance criteria above shall apply.

Measurement data:

Test specifications:

Test location	Semi anechoic chamber with floor absorbers
Frequency band (MHz)	80 to 6000 (*)
Test signal level (V/m)	3
Exclusion Bands – multi-mode (MHz)	(see chapter 4.5)
Frequency step	1%
Dwell time	1 s
Performance criterion	A

Test results:

		Test results / EUT side exposure results			
Frequency range (MHz)	Antenna polarization	Front	Back	Left	Right
80 – 1000	V	PASS	PASS	PASS	PASS
1000 – 6000 (*)	V	PASS	PASS	PASS	PASS
80 – 1000	H	PASS	PASS	PASS	PASS
1000 – 6000 (*)	H	PASS	PASS	PASS	PASS

Note (*): The exclusion bands are applicable in this frequency range.

Remarks: No failure according to the performance criteria in the used standard was observed during or after the test.

Result of test: PASS

8.2 Electrostatic discharge

General description:

This test is applicable for radio equipment and associated ancillary equipment. This test shall be performed on a representative configuration of the radio equipment, the associated ancillary equipment, or a representative configuration of the combination of radio and ancillary equipment. This test assesses the ability of the EUT to operate as intended in the event of an electrostatic discharge.

Test method:

The test method shall be in accordance with CENELEC EN 61000-4-2.

For radio equipment and ancillary equipment the following requirements and evaluation of test results shall apply.

The test severity level for contact discharge shall be ± 4 kV and for air discharge ± 8 kV. All other details, including intermediate test levels, are contained within CENELEC EN 61000-4-2.

Electrostatic discharges shall be applied to all exposed surfaces of the EUT except where the user documentation specifically indicates a requirement for appropriate protective measures.

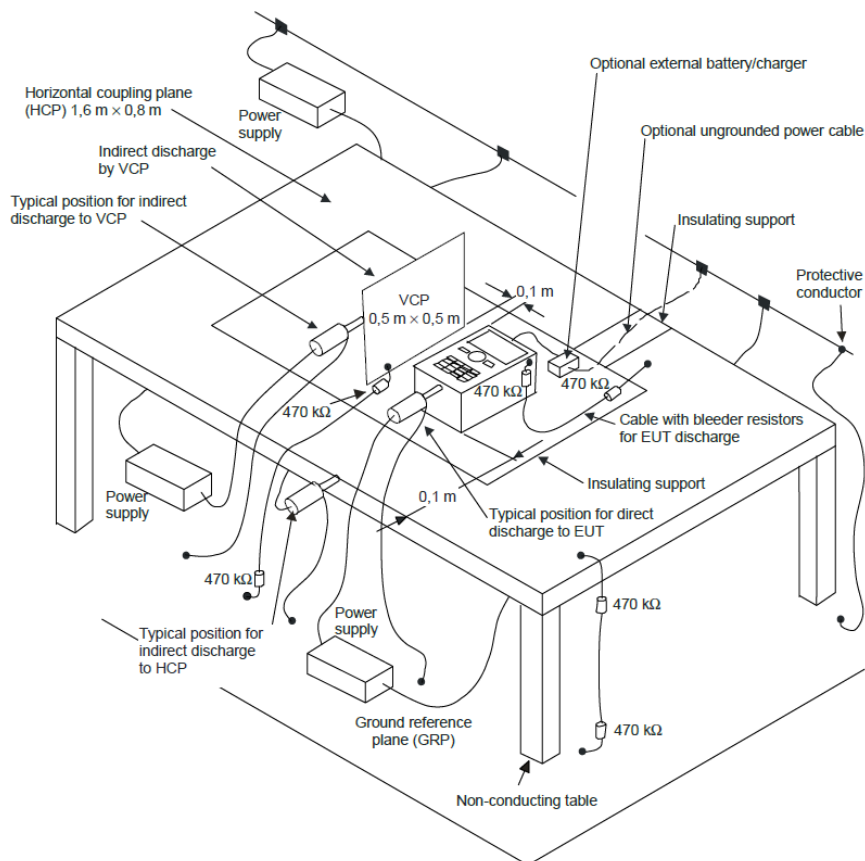

Example of test set-up for table-top equipment, laboratory tests:

Test conditions:

Environmental conditions	Required value	Actual value
Temperature:	15 °C ÷ 35 °C	22.3 °C
Humidity:	30 % ÷ 75 %	35 %
Pressure:	860 hPa ÷ 1060 hPa	1020 hPa

Performance criteria:

For transmitters the performance criteria for transient phenomena (see chap. 5) for transmitter shall apply.
 For receivers the performance criteria for transient phenomena for receivers shall apply.
 For ancillary equipment the pass/failure criteria supplied by the manufacturer shall apply, unless the ancillary equipment is tested in connection with a receiver or transmitter in which case the corresponding performance criteria above shall apply.

Measurement data:

The EUT was tested as a table-top device.
 Test specifications and results:

Discharge type	Discharge level (kV)	Discharge location	Number of discharges per location for each polarity (number of locations)	Performance criterion	Test result
Direct air discharge	±2, ±4, ±8	Non-metallic parts	10 (10)	B	PASS
Direct contact discharge	±4	Metallic parts	0 (no metallic parts)	B	PASS
Indirect contact discharge	±4	HCP - Front	10	B	PASS
Indirect contact discharge	±4	HCP - Left	10	B	PASS
Indirect contact discharge	±4	HCP - Right	10	B	PASS
Indirect contact discharge	±4	HCP - Rear	10	B	PASS
Indirect contact discharge	±4	VCP - Front	10	B	PASS
Indirect contact discharge	±4	VCP - Left	10	B	PASS
Indirect contact discharge	±4	VCP - Right	10	B	PASS
Indirect contact discharge	±4	VCP - Rear	10	B	PASS

Note: The EUT was without exposed conductive surfaces.
 HCP – Horizontal coupling plane
 VCP – Vertical coupling plane

Each kind of the discharge (with positive and negative polarity) and voltage was applied ten times to the accessible parts of the sample in the each of the working mode. Duration between applied of the discharge was > 5 seconds.

Points of ESD Test:

- Air discharge
- Contact discharge

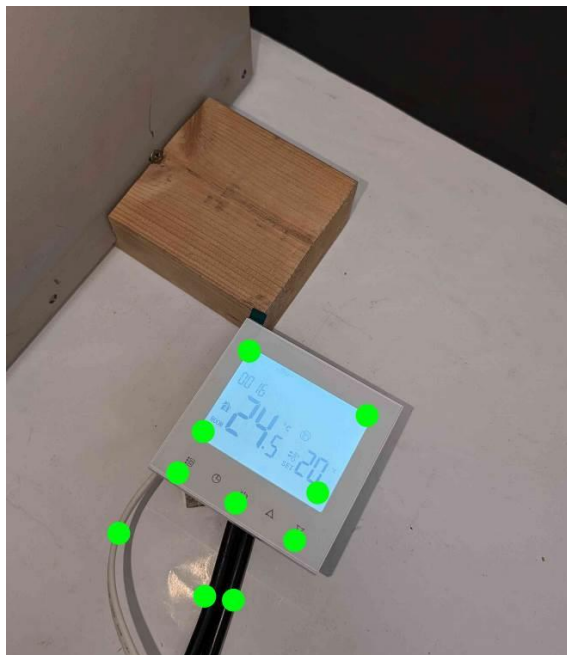

Remarks:

No failure according to the performance criteria in the used standard was observed during or after the test. After each discharge to the screen, the artefacts appeared but they disappeared in a second. No operating state has changed.

Result of test: PASS

8.3 Fast transients, common mode

General description:

This test shall be performed on the AC mains power port (if any) of radio equipment and associated ancillary equipment.

This test shall be additionally performed on signal ports, wired network ports, control ports, and DC power ports, of radio equipment and associated ancillary equipment, if the cables may be longer than 3 m.

Where this test is not carried out on any port because the manufacturer declares that it is not intended to be used with cables longer than 3 m, a list of ports, which were not tested for this reason, shall be included in the test report.

This test shall be performed on a representative configuration of the radio equipment or a representative configuration of the combination of radio and ancillary equipment.

This test assesses the ability of the EUT to operate as intended in the event of fast transients present on one of the input/output ports.

Test method:

The test method shall be in accordance with CENELEC EN 61000-4-4.

The following requirements and evaluation of test results shall apply:

- the test level for signal ports, wired network ports (excluding xDSL), and control ports shall be 0.5 kV open circuit voltage at a repetition rate of 5 kHz as given in CENELEC EN 61000-4-4;
- the test level for xDSL wired network ports shall be 0.5 kV open circuit voltage at a repetition rate of 100 kHz as given in CENELEC EN 61000-4-4;
- the test level for DC power input ports shall be 0.5 kV open circuit voltage at a repetition rate of 5 kHz as given CENELEC EN 61000-4-4;
- the test level for AC mains power input ports shall be 1 kV open circuit voltage at a repetition rate of 5 kHz as given CENELEC EN 61000-4-4

Performance criteria:

For transmitters the performance criteria (see chap. 5) for transient phenomena for transmitter shall apply.

For receivers the performance criteria for transient phenomena for receivers shall apply.

For ancillary equipment the pass/failure criteria supplied by the manufacturer shall apply, unless the ancillary equipment is tested in connection with a receiver or transmitter in which case the corresponding performance criteria shall apply.

Measurement data:

Direct coupling with a coupling/decoupling network:

Impulse	Level	Coupling	Required criteria	Test result
5/50 ns	±1.0 kV	L1	B	PASS
5/50 ns	±1.0 kV	N	B	PASS
5/50 ns	±1.0 kV	L1+N	B	PASS

Remarks: No failure according to the performance criteria in the used standard was observed during or after the test.

Result of test: PASS

8.4 Radio frequency, common mode

General description:

This test shall be performed on the AC mains power port (if any) of radio equipment and associated ancillary equipment.

This test shall be additionally performed on signal ports, wired network ports, control ports, and DC power ports, of radio equipment and associated ancillary equipment, if the cables may be longer than 3 m.

Where this test is not carried out on any port because the manufacturer declares that it is not intended to be used with cables longer than 3 m, a list of ports, which were not tested for this reason, shall be included in the test report.

This test shall be performed on a representative configuration of the radio equipment, the associated ancillary equipment, or a representative configuration of the combination of radio and ancillary equipment.

This test assesses the ability of the EUT to operate as intended in the presence of a radio frequency disturbance on the input/output ports.

Test method:

The test method shall be in accordance with CENELEC EN 61000-4-6.

The following requirements and evaluation of test results shall apply:

- the test level shall be severity level 2 as given in CENELEC EN 61000-4-6 corresponding to 3 V rms unmodulated. The test signal shall then be amplitude modulated to a depth of 80 % by a sinusoidal audio signal of 1 000 Hz. If the wanted signal is modulated at 1 000 Hz, then the test signal of 400 Hz shall be used;
- the test shall be performed over the frequency range 150 kHz to 80 MHz with the exception of an exclusion band for transmitters, and for receivers and duplex transceivers;
- for receivers and transmitters the stepped frequency increments shall be 1 % frequency increment of the momentary frequency in the frequency range 150 kHz to 80 MHz;
- the injection method to be used shall be selected according to the basic standard CENELEC EN 61000-4-6;
- responses on receivers or receiver parts of transceivers occurring at discrete frequencies which are narrow band responses (spurious responses), are disregarded from the test;
- the dwell time of the test phenomena at each frequency shall not be less than the time necessary for the EUT to be exercised and to be able to respond;
- the frequencies of the immunity test signal selected and used during the test shall be recorded in the test report.

Typical test setup:

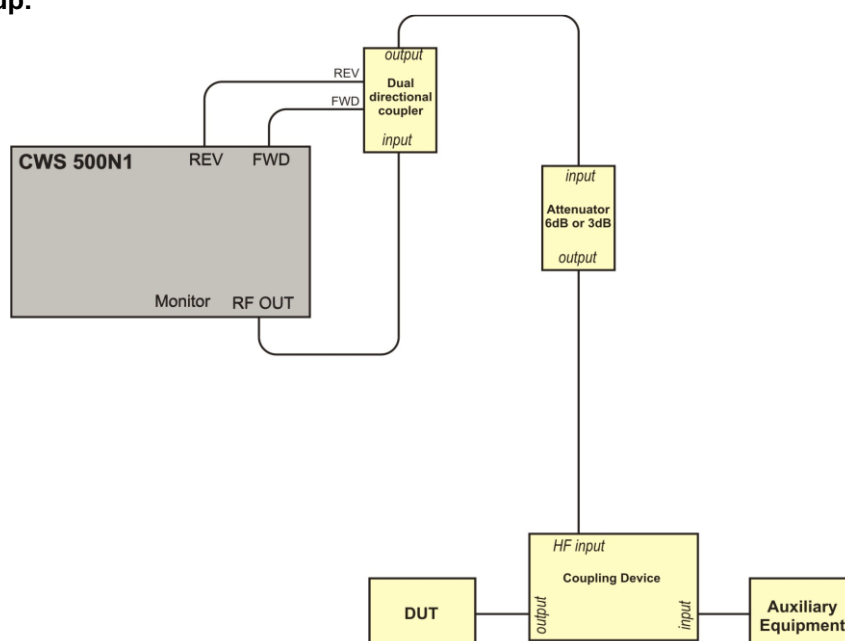

Performance criteria:

For transmitters the performance criteria for (see chap. 5) transient phenomena for transmitter shall apply.
 For receivers the performance criteria for transient phenomena for receivers shall apply.
 For ancillary equipment the pass/failure criteria supplied by the manufacturer shall apply, unless the ancillary equipment is tested in connection with a receiver or transmitter in which case the corresponding performance criteria shall apply.

Test severity levels:

Level	Voltage level
1	1 V
2	3 V
3	10 V
x	Specified

NOTE:

- x is an open class. This level can be specified in the product specification.

Measurement data:

Test no.1 Specifications: Input power port	
Test levels and limits defined according to standard 301 489-1 V2.2.3 – AC power port	
Frequency - range	: 0.15 MHz - 80 MHz
Voltage level (EMF)	: <input type="checkbox"/> 1V <input checked="" type="checkbox"/> 3V <input type="checkbox"/> 10V <input type="checkbox"/> x
Modulation	: AM: 80 % / sine 1000Hz
Frequency step	: 1 %
Dwell time	: 1 sec.
Cable description	: AC 230 V
Test specification	: Coupling with Coupling/Decoupling Network (CDN) or Electromagnetic Injection Clamp
Coupling via	: CDN M2/M3
Screening	: Unscreened
Status	: Active
Signal transmission	: Analog
Test result	
The requirements are	: FULFILLED
Performance required criterion	: A
Performance observed criterion	: A
Remarks:	: No failure according to the performance criteria in the used standard was observed during or after the test.

8.5 Transients and surges in the vehicular environment

General description:

These tests are applicable to radio and ancillary equipment intended for vehicular use.

These tests shall be performed on nominal 12V and 24V DC supply voltage input ports of mobile radio and ancillary equipment, which are also intended for mobile use in vehicles.

These tests shall be performed on a representative configuration of the mobile radio equipment, the associated ancillary equipment, or a representative configuration of the combination of radio and ancillary equipment.

These tests assess the ability of the EUT to operate as intended in the event of transients and surges present on their DC power input ports in a vehicular environment.

Test method:

The test method shall be in accordance with ISO 7637-2 for 12V DC and 24V DC powered equipment.

The test method shall be in accordance with ISO 7637-2, applying pulses 1, 2a, 2b, 3a, 3b, and 4, using immunity test level III. For the purpose of EMC testing it is sufficient to apply pulses 1, 2a, 2b and 4, 10 times each, and apply the test pulses 3a and 3b for 20 minutes each.

Performance criteria:

For transmitters, pulse 3a and 3b the performance criteria for continuous phenomena for transmitters shall apply.

For pulse 1, 2a, 2b, and 4 the performance criteria for transient phenomena for transmitter shall apply, with the exception that a communication link need not to be maintained during the EMC exposure and may have to be re-established.

For receivers, pulse 3a and 3b the performance criteria for continuous phenomena for receivers shall apply.

For pulse 1, 2a, 2b, and 4 the performance criteria for transient phenomena for receivers shall apply, with the exception that a communication link need not to be maintained during the EMC exposure and may have to be re-established.

For ancillary equipment the pass/failure criteria supplied by the manufacturer shall apply, unless the ancillary equipment is tested in connection with the radio equipment in which case the corresponding performance criteria above shall apply.

Measurement data:

Test not applicable to the EUT.

8.6 Voltage dips and interruptions

General description:

This test shall be performed on the AC mains power port (if any) of radio equipment and associated ancillary equipment.

These tests shall be performed on a representative configuration of the radio equipment, the associated ancillary equipment, or a representative configuration of the combination of radio and ancillary equipment. These tests assess the ability of the EUT to operate as intended in the event of voltage dips and interruptions present on the AC mains power input ports.

Test method:

The following requirements and evaluation of test results shall apply.

The test method shall be in accordance with CENELEC EN 61000-4-11 or for equipment requiring a mains current of greater than 16 A CENELEC EN 61000-4-34 shall be used.

The test levels shall be:

- voltage dip: 0 % residual voltage for 0.5 cycle;
- voltage dip: 0 % residual voltage for 1 cycle;
- voltage dip: 70 % residual voltage for 25 cycles (at 50 Hz);
- voltage interruption: 0 % residual voltage for 250 cycles (at 50 Hz).

Performance criteria:

For a voltage dip the following performance criteria apply:

- for transmitters the performance criteria for transient phenomena for transmitter shall apply (see clause 6 of the relevant part of ETSI EN 301 489 series dealing with the particular type of radio equipment);
- for receivers the performance criteria for transient phenomena for receiver shall apply (see clause 6 of the relevant part of ETSI EN 301 489 series dealing with the particular type of radio equipment);
- for ancillary equipment the pass/failure criteria supplied by the manufacturer (see clause 6.4) shall apply, unless the ancillary equipment is tested in connection with a receiver or transmitter in which case the corresponding performance criteria above shall apply.

For a voltage interruption the following performance criteria apply:

- in the case where the equipment is fitted with or connected to a battery back-up, the performance criteria for transient phenomena for transmitters or for receivers shall apply (see clause 6 of the relevant part of ETSI EN 301 489 series dealing with the particular type of radio equipment);
- in the case where the equipment is powered solely from the AC mains supply (without the use of a parallel battery back-up) volatile user data may have been lost and if applicable the communication link need not to be maintained and lost functions should be recoverable by user or operator;
- no unintentional responses shall occur at the end of the test;
- in the event of loss of function(s) or in the event of loss of user stored data, this fact shall be recorded in the test report;
- for ancillary equipment the pass/failure criteria supplied by the manufacturer (see clause 6.4) shall apply, unless the ancillary equipment is tested in connection with a receiver or transmitter in which case the corresponding performance criteria above shall apply.

Measurement data:

Supply voltage	Frequency	Time of dips	Ratio of dips	Required criteria	Test result
230 V	50 Hz	10 ms	0 %	B	PASS
230 V	50 Hz	20 ms	0 %	B	PASS
230 V	50 Hz	500 ms	70 %	C	PASS
230 V	50 Hz	5000 ms	0 %	C	PASS

Result of test: PASS

8.7 Surges

General description:

This test shall be performed on the AC mains power input port (if any) of radio equipment and associated ancillary equipment.

This test shall be additionally performed on wired network ports, if any.

These tests shall be performed on a representative configuration of the radio equipment, the associated ancillary equipment, or a representative configuration of the combination of radio and ancillary equipment. These tests assess the ability of the EUT to operate as intended in the event of surges present on the AC mains power input ports and wired network ports.

Test method:

The test method shall be in accordance with CENELEC EN 61000-4-5.

The requirements and evaluation of test results given in clause 9.8.2.1 of EN 301 489-1 (wired network ports, outdoor cables), clause 9.8.2.2 of EN 301 489-1 (wired network ports, indoor cables) and clause 9.8.2.3 of EN 301 489-1 (mains ports) shall apply, but no test shall be required where normal functioning cannot be achieved, because of the impact of the CDN on the EUT.

Test method for mains ports:

The test level for ac mains power input ports shall be 2 kV line to ground, and 1 kV line to line, with the output impedance of the surge generator as given in CENELEC EN 61000-4-5 [5]. In telecom centres 1 kV line to ground and 0.5 kV line to line shall be used.

The test generator shall provide the 1.2/50 μ s pulse as defined in CENELEC EN 61000-4-5 [5].

Performance criteria:

For transmitters the performance criteria for transient phenomena for transmitters shall apply (see clause 6 of the relevant part of ETSI EN 301 489 series [i.13] dealing with the particular type of radio equipment). For receivers the performance criteria for transient phenomena for receivers shall apply (see clause 6 of the relevant part of ETSI EN 301 489 series [i.13] dealing with the particular type of radio equipment). For ancillary equipment the pass/failure criteria supplied by the manufacturer (see clause 6.4) shall apply, unless the ancillary equipment is tested in connection with a receiver or transmitter in which case the corresponding performance criteria above shall apply.

Measurement data:

AC power port:

Pulse	Voltage	Coupling	Required criteria	Test results - polarity			
				0°	90°	180°	270°
1.2/50 μ s	\pm 1.0 kV	L1-N	B	PASS	PASS	PASS	PASS

Remarks: No failure according to the performance criteria in the used standard was observed during or after the test.

Result of test: PASS

9 MEASUREMENT UNCERTAINTIES

The measurement uncertainties are based on a 95% confidence level (based on the coverage factor $k = 2$) and calculated according to CISPR 16-4 and internal document 2017/1/316/NM of Technický skúšobný ústav Piešťany, a. s.

The recorded value of measurement uncertainty is, for each measurement result, equal to or lower than the values required by the test-related standard.

If there are some measured values of the tested parameters in the measurement uncertainty band with their respective limits, there is the possibility that this sample or similar, selected out of production, may not meet the required limit if tested by another laboratory.

Uncertainty		
Conducted RF emissions	< 3.36 dB	
Radiated RF emissions	< 5.71 dB	
Harmonic current emissions EN 61000-3-2	< 5 %	
Voltage fluctuations and flicker EN 61000-3-3	< 8 %	
Electrostatic discharge EN 61000-4-2	< 0.3 kV for ± 4 kV < 0.4 kV for ± 8 kV < 0.6 kV for ± 15 kV	
Radio frequency electromagnetic field EN 61000-4-3	< 1.67 dB	
Electrical fast transients and bursts EN 61000-4-4	Pulse rise time	< 6.2 %
	Peak voltage level	8.64 % (related to 3.75 kV)
	Pulse width	< 5.9 %
Surges EN 61000-4-5	Pulse rise time	< 13.3 %
	Peak voltage level	8.63 % (related to 3.85 kV)
	Pulse width	< 5.9 %
Radio frequency conducted disturbance EN 61000-4-6	< 1.25 dB	
Voltage dips and interruptions EN 61000-4-11	< 3 dB	

10 PHOTOGRAPHS FROM TEST SITE

EUT:



EUT product label design:

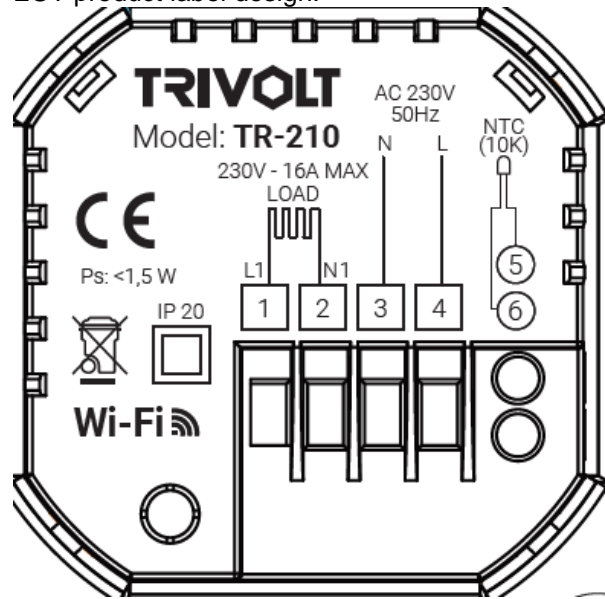

AE1:

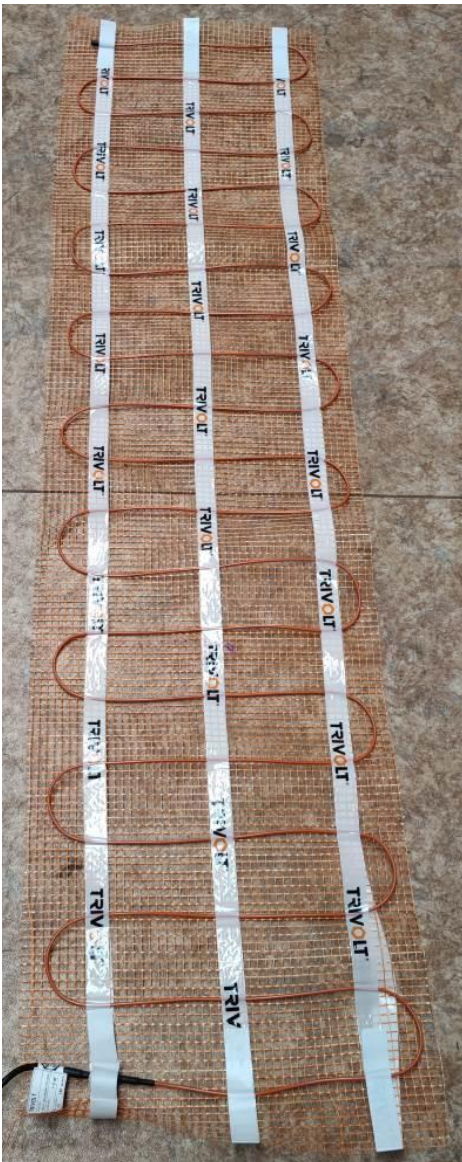

EUT in anechoic chamber, radiated emissions test:

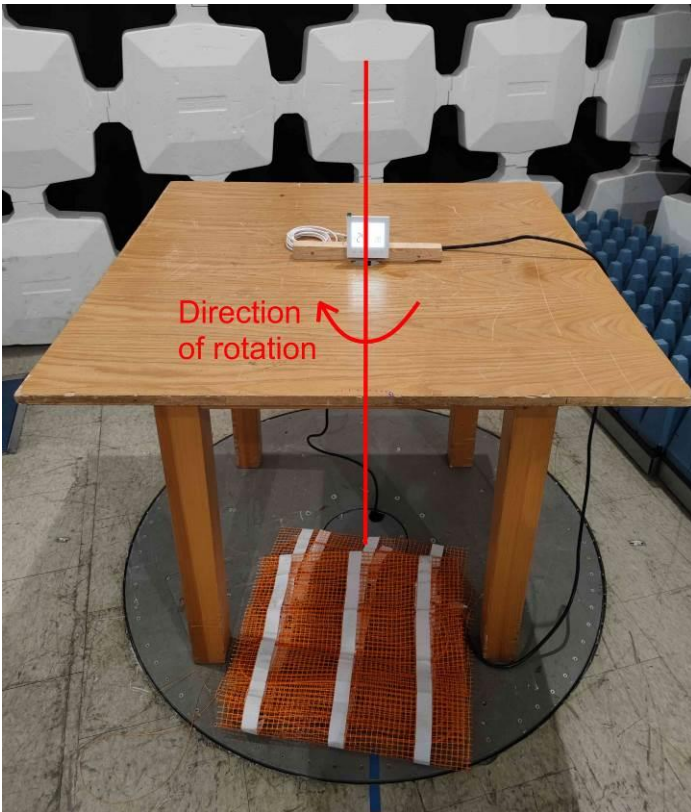

End of test report